

Sabine

Model # SA.194.00

1-Compartment Food Service Sink

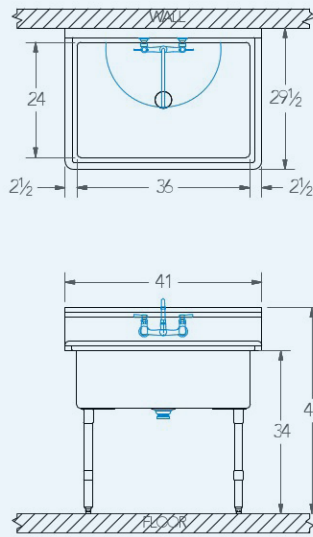

Bowl (Lg x Wd x Dp)
36" x 24" x 12"

Drainboard
Left: 0"
Right: 0"

Overall (Lg x Wd x Ht)
41" x 29 1/2" x 43"

Material
16 gauge, stainless steel

Faucet Holes
1-1/8" Dia 8" Centers

Drain
3-1/2" Dia Opening

Included:



Matched Faucet



Basket Drain(s)



Install Kit

Additional Features

- NSF approved construction
- R 3/4" coved compartments
- 12" deep compartments
- Stainless steel legs
- Stainless steel feet
- 9" tile-edge backsplash
- 1-1/2" sanitary rolled-rim
- D 3-1/2" recessed drain opening
- Specification grade hardware included
- 5-year warranty
- Made in Texas